

Session Objectives: 1. Introduce: Forehand Pass & Receive,
2. Review: ABC's, V Start, Tight Turns, 1 Foot Stop, Backward Striding, Stationary Stickhandling

10 MIN

WARM-UP

WARM UP (1.1.03/1.1.04/1.6.04/1.6.12/1.1.12)

Players skate anywhere on ice. Coaches are "it" and try to tag players. If tagged, players must go to the "Skill Doctor" at the referee's circle who assigns a skill task which player performs before returning to the game. Suggested skill tasks: balance on one foot, jumping on one foot, 360's, crossovers - three quick, lateral crossovers.

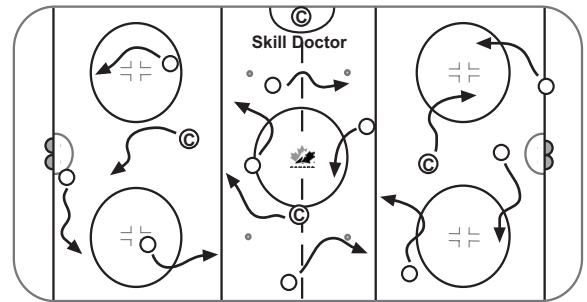

20 MIN

SKILL STATIONS #1

1. V-START - TIGHT TURNS (1.3.02/1.6.02)

Review key points of front start and demonstrate while stationary for organization. Players in basic stance. On signal they practice opening skates into a "V" position by toeing outwards. Try to open as far as possible. Players partner off. Place pylons 1/2 way across ice - 1 pylon for every pair of players. On signal 1st player in each line opens skates into "V" position and takes 4-5 running strides and continues to pylon, executes a tight turn around pylon and returns to partner who then goes. Review form and correct flaws. Continuous drill. Halfway through change direction of turn.

2. FOREHAND PASS AND RECEIVE (2.3.01)

Review key points for receiving pass on forehand. Divide into as many groups as there are coaches. Formation as diagrammed, coach at centre. Coach passes to each player around him. Each player returns the pass. Provide feedback.

3. 1 FOOT STOP (1.3.07)

Review and demonstrate 1 foot stops. Emphasize glide before the stop. Players line up on boards. Each player in turn skates to 1st pylon and executes stop facing direction of next pylon. Next player goes when player in front stops at pylon. Review technique and correct.

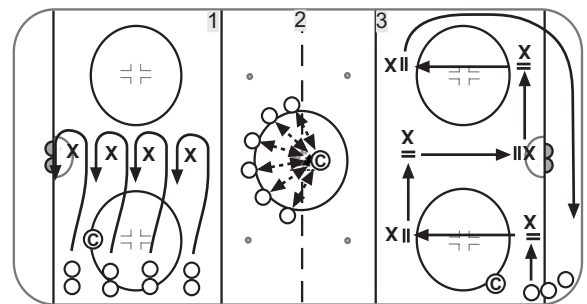

20 MIN

SKILL STATIONS #2

1. RED LIGHT GREEN LIGHT (1.3.11)

On "green light" start skating backward across ice using C-cut. On "yellow light" glide backwards. On red light" stop using backward V-stop.

2. STATIONARY STICKHANDLING (2.1.10)

Line players up in stickhandling position with a puck in front of them. Review and demonstrate puck control - rotation. Have players rotate puck both directions.

3. TAG

Coach is "it". All players (& coaches) skate backwards at all times. Once tagged a player helps "it". Players carry stick while they are "free", discard stick once they are tagged (so others can tell they are "it"). Last player left wins.

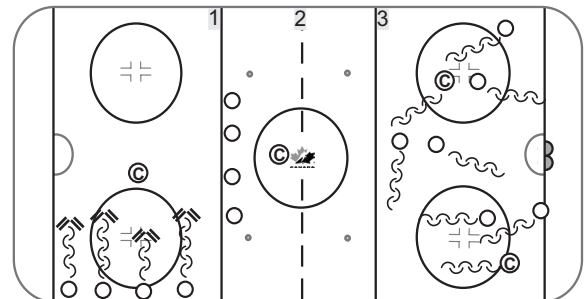

10 MIN

FUN GAME

SOCCER

Play soccer in cross ice format. No sticks.

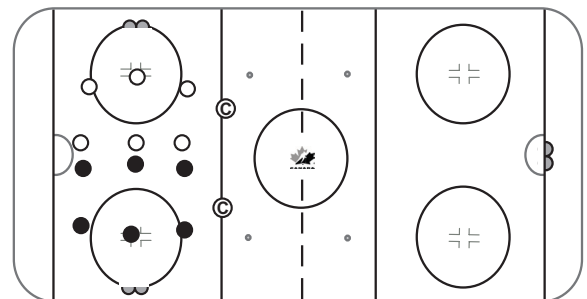

Do not forget to incorporate the Warm-up session prior to introducing your skill stations and the fun game at the end of your practice from the previous page.
 Additional ice stations: You may choose either Option 1: Skill Stations #1 plus Skill Skations #2, Option 2: Skills Stations #2 repeated 3 times or Option 3: Skill Stations #3 only

SKILL STATIONS #1 - 4 STATION SETUP

- 1. FOREHAND PASS AND RECEIVE (2.3.01)
- 2. V-START - TIGHT TURNS (1.3.02/1.6.02)
- 3. STATIONARY STICKHANDLING (2.1.10)
- 4. RED LIGHT GREEN LIGHT (1.3.11)

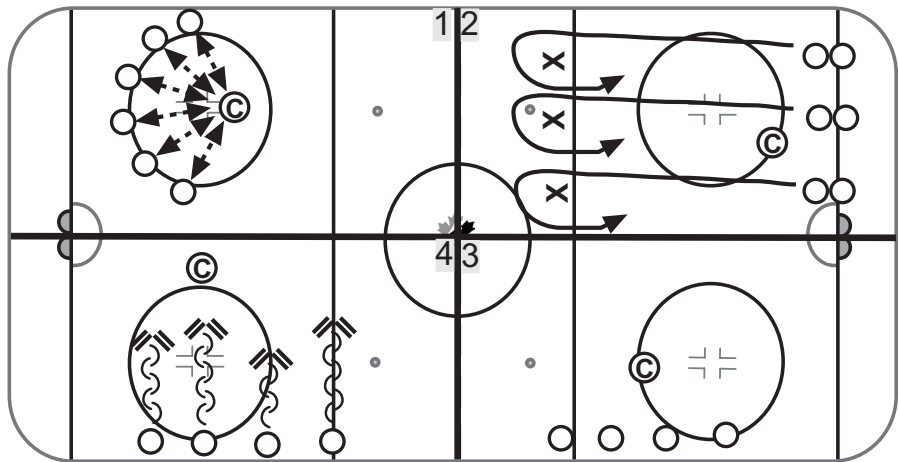

SKILL STATIONS #2 - 2 STATION SETUP

- 1. TAG
- 2. 1 FOOT STOP (1.3.07)

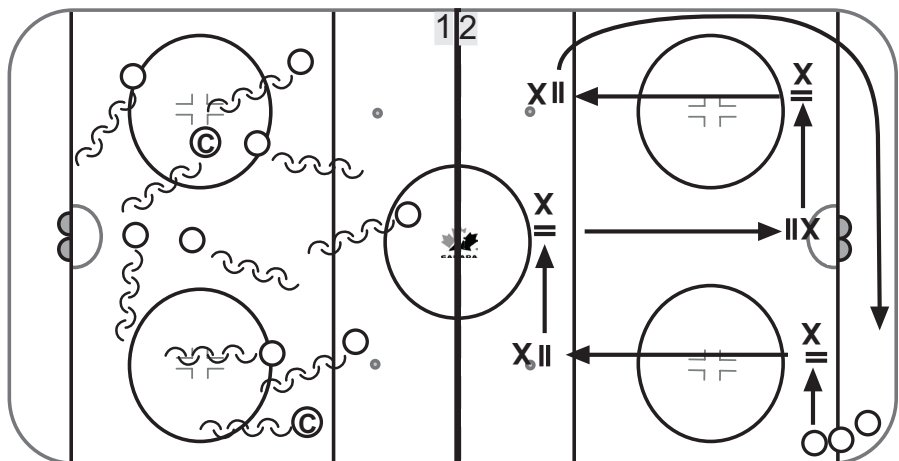

SKILL STATIONS #3 - 6 STATION SETUP

- 1. FOREHAND PASS AND RECEIVE (2.3.01)
- 2. STATIONARY STICKHANDLING (2.1.10)
- 3. V-START - TIGHT TURNS (1.3.02/1.6.02)
- 4. RED LIGHT GREEN LIGHT (1.3.11)
- 5. TAG
- 6. 1 FOOT STOP (1.3.07)

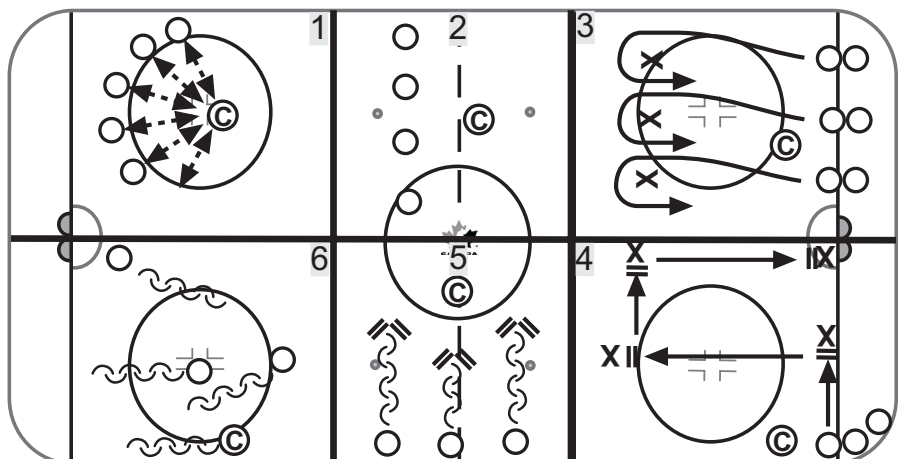

Session Objectives: 1. Introduce: Backhand Pass & Receive, Pick Up Puck on Boards
 2. Review: ABC's, Forehand Pass & Receive, 2 Foot Stop, Skating & Shooting

10 MIN

WARM-UP

WARM UP (1.5.02/1.5.04/1.1.12/1.1.09)

Skate counterclockwise direction, between blue lines execute backward c-cuts, backward glide on one foot, lateral crossovers, gliding with knee bend, speed up. Add pucks if desired.

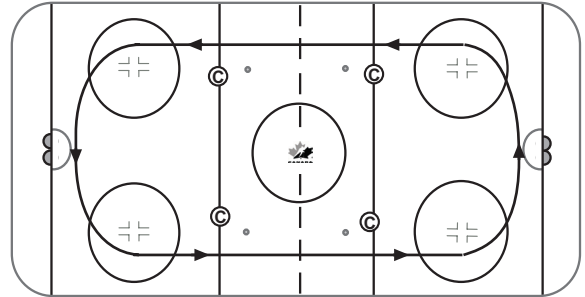

20 MIN

SKILL STATIONS #1

1. BACKHAND PASS AND RECEIVE (2.3.02)

Demonstrate key points for receiving pass on backhand. Divide into as many groups as there are coaches. Formation as diagrammed, coach at centre. Coach passes to each player around him on backhand. Each player returns the pass on backhand. Provide feedback.

2. STATIONARY STICKHANDLING (2.1.11/2.1.12)

Line players up in stickhandling position with a puck in front of them. Have players execute the toe drag to the side and in front of body.

3. FOREHAND PASS AND RECEIVE (2.3.01)

Review key points for receiving pass on forehand. Divide into as many groups as there are coaches. Formation as diagrammed, coach at centre. Coach passes to each player around him. Each player returns the pass. Provide feedback. Gradually speed up passes. Pass to players out of order. Give players a turn at centre.

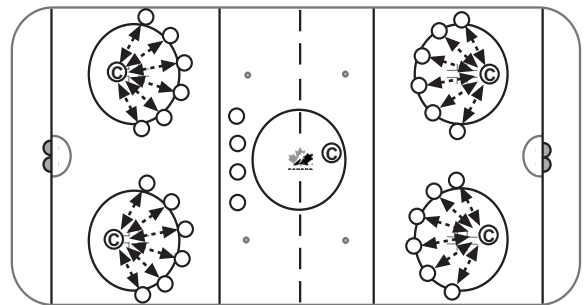

20 MIN

SKILL STATIONS #2

1. 1 FOOT STOP (1.3.07)

Review and demonstrate 1 foot stops. Emphasize glide before the stop. Players line up on boards. Each player in turn skates to 1st pylon and executes stop facing direction of next pylon. Next player goes when player in front stops at pylon. Review technique and correct.

2. C-CUTS AROUND CIRCLE (1.6.06/1.6.08)

Review and Demonstrate key points. Players line up in neutral zone and on coaches signal, execute c-cuts around the circle with the outside foot. Repeat with both feet

3. PICK UP PUCK ON BOARDS (5.2.1.2)

Review and demonstrate new safety rule: never skate straight at the boards to pick up a puck - always skate along the boards. Players line up in the face-off circle. Place pylons along goal line to create barrier players must go around. Coach spots puck along boards on other side of barrier. Player must skate around barrier to create safe angle on the puck, pick up puck, carry puck around top of face-off circle and shoot from slot. Send players in quick succession. Remove barrier but make sure players still create safe angle on the puck.

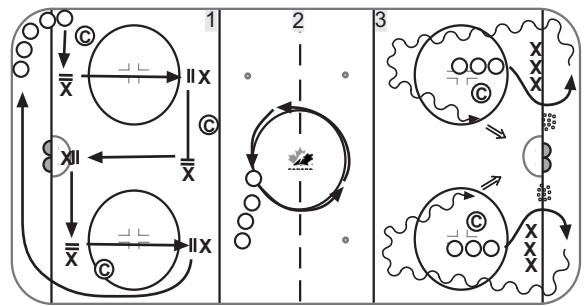

10 MIN

FUN GAME

SCRIMMAGE - CROSS ICE

No nets - use 1 pylon - must hit pylon to score - no goalies. Continuous play - if a goal is scored players give puck to coach who shoots it in to area and play continues. If stronger players monopolize the puck, add another puck (or two).

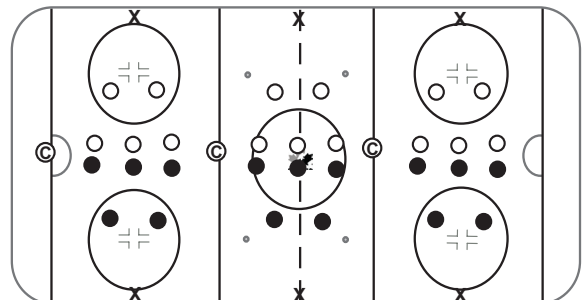

Do not forget to incorporate the Warm-up session prior to introducing your skill stations and the fun game at the end of your practice from the previous page.

Additional ice stations: You may choose either Option 1: Skill Stations #1 plus Skill Skations #2, Option 2: Skills Stations #2 repeated 3 times or Option 3: Skill Stations #3 only

SKILL STATIONS #1 - 4 STATION SETUP

1. PICK UP PUCK ON BOARDS (5.2.1.2)
2. BACKHAND PASS AND RECEIVE (2.3.02)
3. FOREHAND PASS AND RECEIVE (2.3.01)
4. STATIONARY STICKHANDLING (2.1.11/2.1.12)

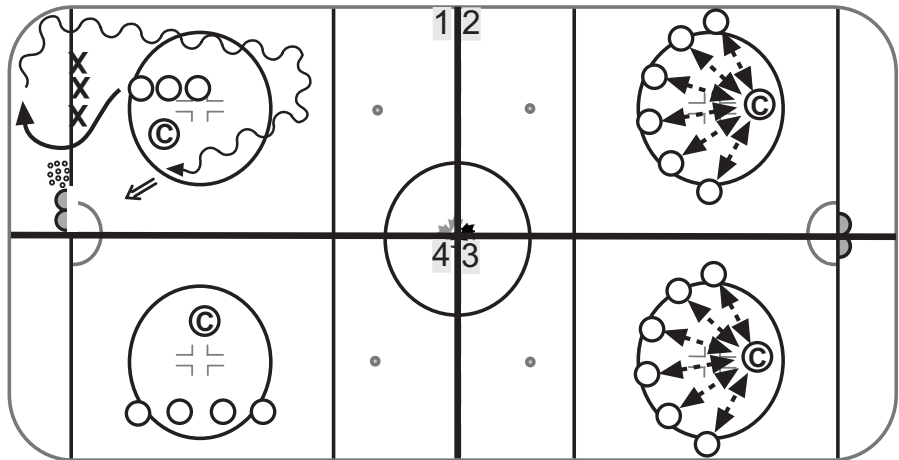

SKILL STATIONS #2 - 2 STATION SETUP

1. C-CUTS AROUND CIRCLE (1.6.06/1.6.08)
2. 1 FOOT STOP (1.3.07)

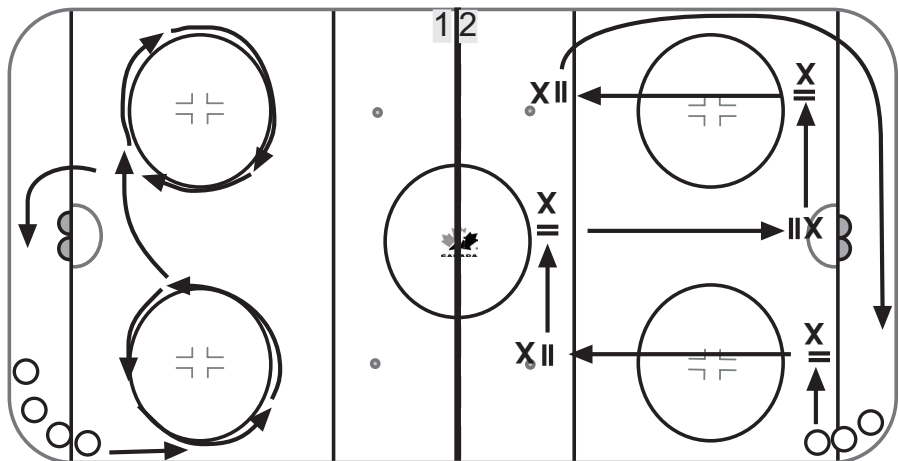

SKILL STATIONS #3 - 6 STATION SETUP

1. BACKHAND PASS AND RECEIVE (2.3.02)
2. STATIONARY STICKHANDLING (2.1.11/2.1.12)
3. 1 FOOT STOP (1.3.07)
4. PICK UP PUCK ON BOARDS (5.2.1.2)
5. FOREHAND PASS AND RECEIVE (2.3.01)
6. C-CUTS AROUND CIRCLE (1.6.06/1.6.08)

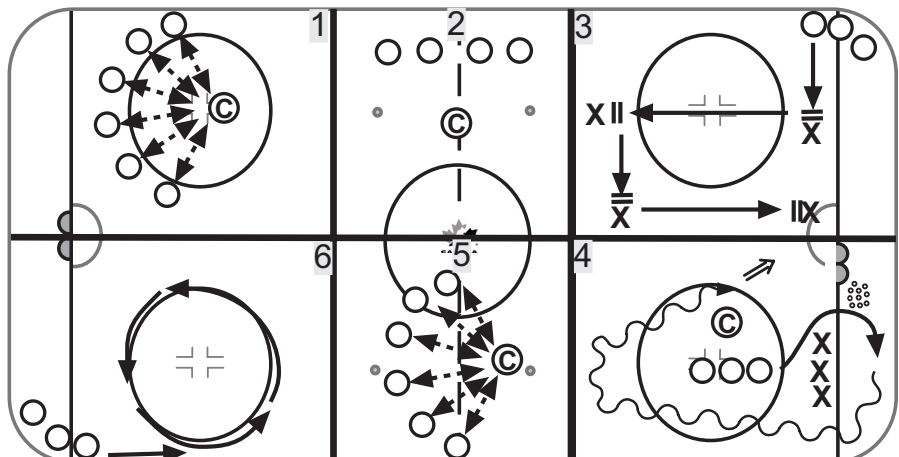

Session Objectives: 1. Introduce: Skating & Passing

2. Review: Forehand Pass & Receive, Backhand Pass & Receive, Pick Up Puck on Boards, Skating & Shooting, 2 Foot Stop

10 MIN

WARM-UP

WARM UP (1.5.02/1.5.04/1.1.12/1.6.04/1.6.12)

Skate counterclockwise direction; between blue lines execute backward c-cuts, backward glide on one foot, lateral crossovers, 360's, crossovers - three quick. Add pucks if desired.

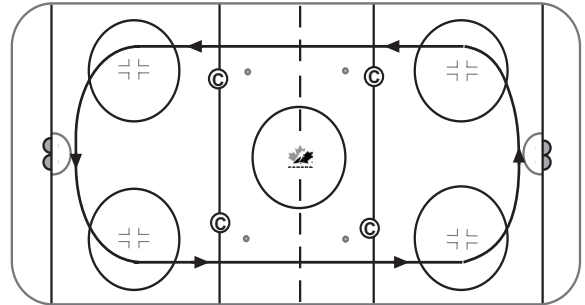

20 MIN

SKILL STATIONS #1

1. FOREHAND PASS & RECEIVE/BACKHAND PASS AND RECEIVE (2.3.01/2.3.02)

Players grouped in triangles or squares approx 4 metres apart. Players pass puck around on forehand. Reverse direction of passes around square or triangle. Repeat but players must pass and receive on backhand. Reverse direction of passes around square or triangle.

2. SKATING & PASSING (2.4.01)

Arrange two teams. Divide each team in two. First player carries puck and passes to first player in opposite line and joins end of opposite line. Player that receives pass skates forward and passes to next player in opposite line etc. First team to exchange all players wins. Repeat going through lines twice.

3. PICK UP PUCK ON BOARDS (5.2.1.2)

Review and demonstrate new safety rule: never skate straight at the boards to pick up a puck - always skate along the boards. Players line up in the face-off circle. Place pylons along goal line to create barrier players must go around. Coach spots puck along boards on other side of barrier. Player must skate around barrier to create safe angle on the puck, pick up puck, carry puck around top of face-off circle and shoot from slot. Send players in quick succession. Remove barrier but make sure players still create safe angle on the puck.

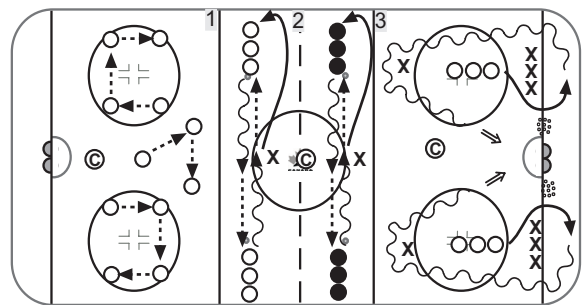

20 MIN

SKILL STATIONS #2

1. TAG

Players play without sticks. Players must skate around end zone with hands on their knees. Coaches are "it" and must tag players. Tagged players must stand still with their arm straight out (flusher). To be freed, another player must skate under the flusher, stop and push arm down (flush the toilet).

2. STATIONARY STICKHANDLING (2.1.11/2.1.12/2.1.13)

Line players up in stickhandling position with a puck in front of them. Have players execute the toe drag to the side, in front of body, and side-front combination.

3. GARBAGE DUMP

Divide group into 2 teams. Assign each team to one face-off circle as a home base. Scatter pucks around end zone. On signal the players must skate around and stop to pick up one object at a time (piece of garbage) and return it to their home base (dump). Players must leave their gloves on. Players must stop at each piece of garbage. Team that collects the most garbage wins.

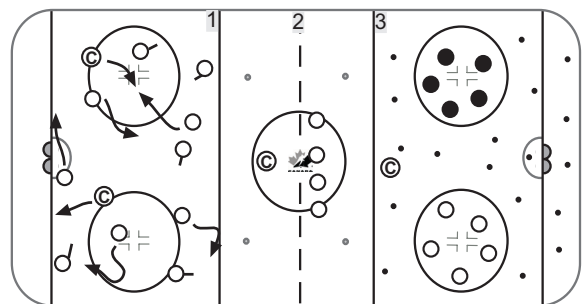

10 MIN

FUN GAME

BRITISH BULLDOG

Players start on side boards and try to skate to other boards. Coaches start as bulldogs and tag players as they skate by. Once tagged, players become bulldogs for next time across. Last player tagged wins. Play until end of time.

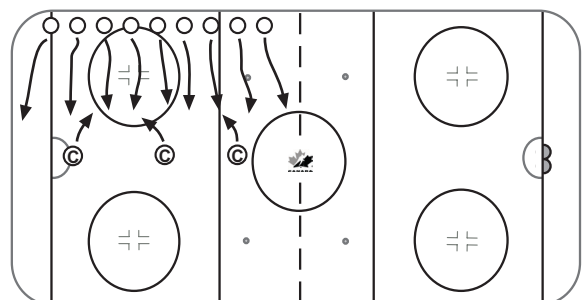

Do not forget to incorporate the Warm-up session prior to introducing your skill stations and the fun game at the end of your practice from the previous page.
 Additional ice stations: You may choose either Option 1: Skill Stations #1 plus Skill Skations #2, Option 2: Skills Stations #2 repeated 3 times or Option 3: Skill Stations #3 only

SKILL STATIONS #1 - 4 STATION SETUP

1. TAG
2. STATIONARY STICKHANDLING (2.1.11/2.1.12/2.1.13)
3. FOREHAND PASS & RECEIVE/BACKHAND PASS AND RECEIVE (2.3.01/2.3.02)
4. 2. SKATING & PASSING (2.4.01)

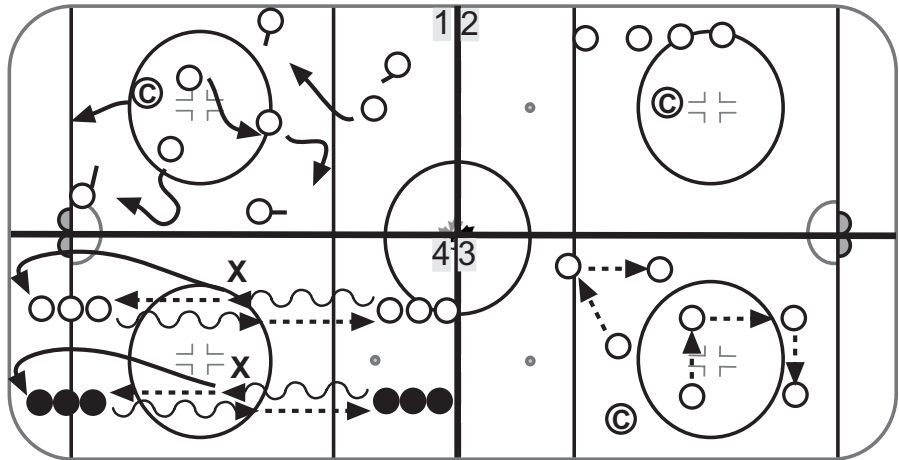

SKILL STATIONS #2 - 2 STATION SETUP

1. GARBAGE DUMP
2. PICK UP PUCK ON BOARDS (5.2.1.2)

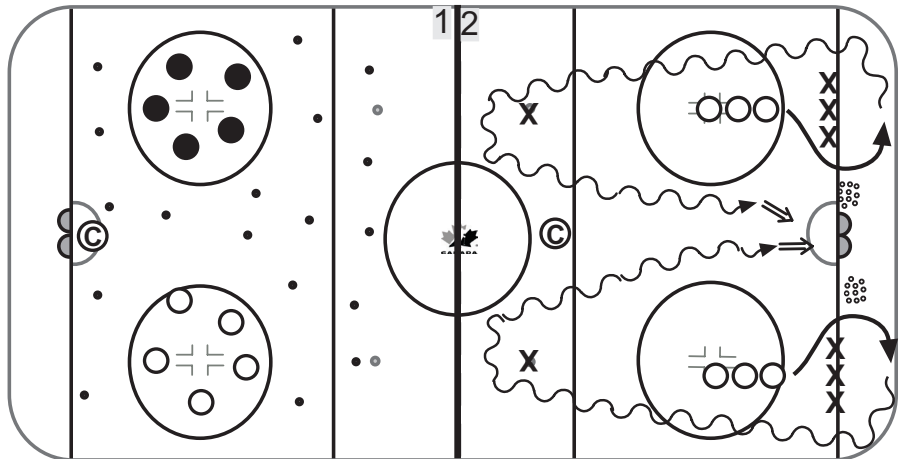

SKILL STATIONS #3 - 6 STATION SETUP

1. STATIONARY STICKHANDLING (2.1.11/2.1.12/2.1.13)
2. GARBAGE DUMP
3. TAG
4. PICK UP PUCK ON BOARDS (5.2.1.2)
5. FOREHAND PASS & RECEIVE/BACKHAND PASS AND RECEIVE (2.3.01/2.3.02)
6. SKATING & PASSING (2.4.01)

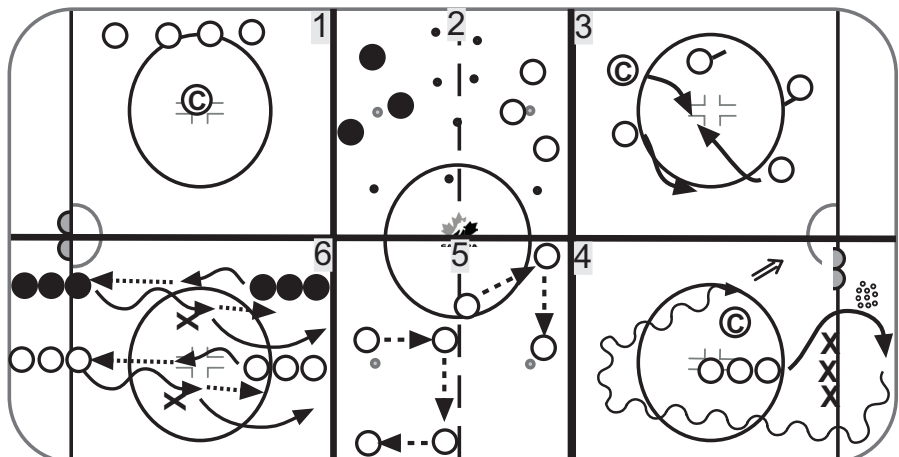

Session Objectives: 1. Review: Skating & Passing, Backhand Pass & Receive, Forehand Pass & Receive, V Start, Tight Turns, 1 Foot Stop

10 MIN

WARM-UP

WARM UP (1.5.02/1.1.12/1.6.04/1.6.12/1.3.07)

Skate counterclockwise direction; between blue lines execute backward c-cuts, lateral crossovers, 360's, crossovers – three quick, and one foot stop on blue lines. Add pucks if desired.

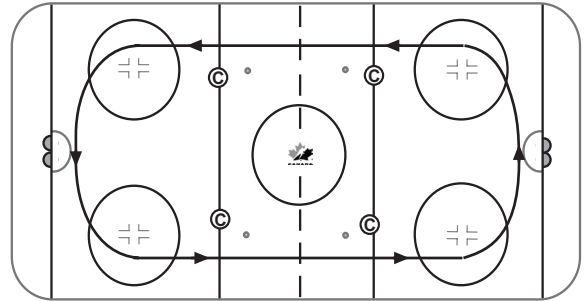

20 MIN

SKILL STATIONS #1

1. PAIRS PASSING (2.4.01/2.4.02)

Players skate in pairs around the zone and pass the puck to each other. Make sure passes are taken on forehand and backhand as appropriate. Reverse direction.

2. CIRCLE KEEP AWAY

Players around the outside of the circle pass the puck to keep it away from the one player in the middle. If a player's pass is intercepted he must trade places with the player in the middle and drill continues. Repeat, but all passes must be given and taken on backhand.

3. BANK PASS (2.3.07)

Start on boards at blue line as shown. Leave with a puck and weave through pylons. Continue to skate along boards about 2 metres from boards and pass puck off boards, receive it and continue skating. Reverse direction.

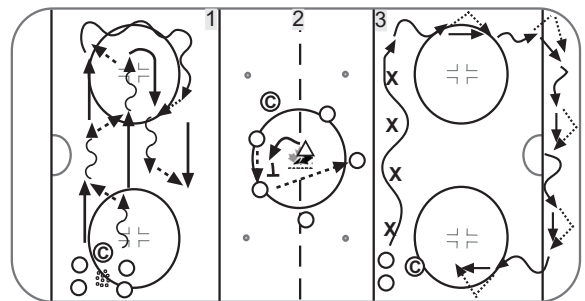

20 MIN

SKILL STATIONS #2

1. PIGGY BANK RACE

Divide players into teams. Start with players kneeling in a line beside their box, crate or pail (the "piggy bank" - small openings are better, forces the player to stop). Equal number of pucks ("coins") for each team placed across the ice. On signal 1st player races to the pucks, executes 1 foot stop, picks up a puck and returns to the bank, stops and deposits coin. Next player goes. First team to put all the coins in the bank wins.

2. V-START/TIGHT TURNS (1.3.02/1.6.02)

Review key points of front start and tight turns demonstrate. Players partner off. Place pylons ½ way across ice - 1 pylon for every pair of players. On signal 1st player in each line opens skates into "V" position and takes 4-5 running strides and continues to pylon, executes a tight turn around pylon and returns to partner who then goes. Review form and correct flaws. Continuous drill. Halfway through change direction of turn. Run relay race. Count proper executions of tight turns by each team in time limit (speed helps but proper execution of skill is what counts). Repeat race executing turns the other direction.

3. TAG

Toilet Bowl Tag - Players play without sticks. Players must skate around end zone with hands on their knees. Coaches are "it" and must tag players. Tagged players must stand still with their arm straight out (flusher). To be freed, another player must skate under the flusher, stop and push arm down (flush the toilet).

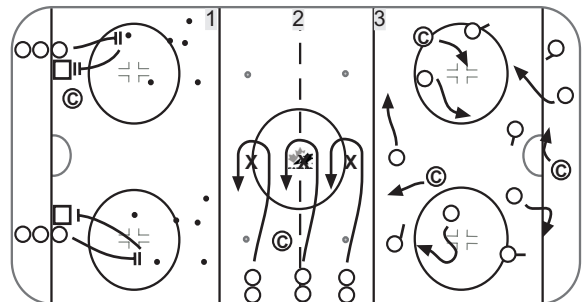

10 MIN

FUN GAME

CROSS ICE SCRIMMAGE

No nets - use 1 pylon - must hit pylon to score - no goalies. Continuous play - if a goal is scored players give puck to coach who shoots it in to area and play continues. If stronger players monopolize the puck, add another puck (or two).

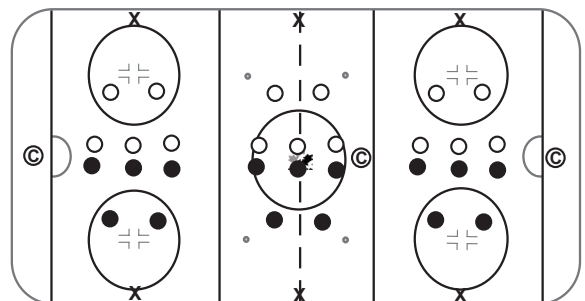

Do not forget to incorporate the Warm-up session prior to introducing your skill stations and the fun game at the end of your practice from the previous page.
 Additional ice stations: You may choose either Option 1: Skill Stations #1 plus Skill Skations #2, Option 2: Skills Stations #2 repeated 3 times or Option 3: Skill Stations #3 only

SKILL STATIONS #1 - 4 STATION SETUP

1. V-START/TIGHT TURNS (1.3.02/1.6.02)
2. CIRCLE KEEP AWAY
3. TAG
4. PIGGY BANK RACE

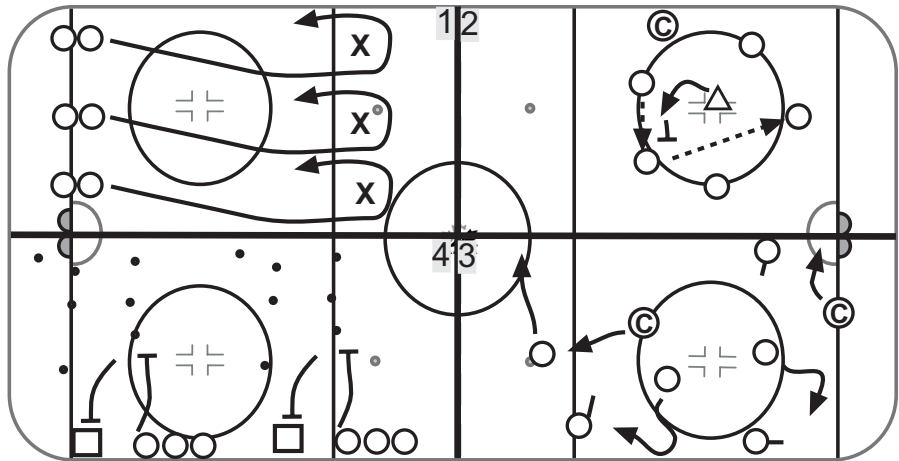

SKILL STATIONS #2 - 2 STATION SETUP

1. PAIRS PASSING (2.4.01/2.4.02)
2. BANK PASS (2.3.07)

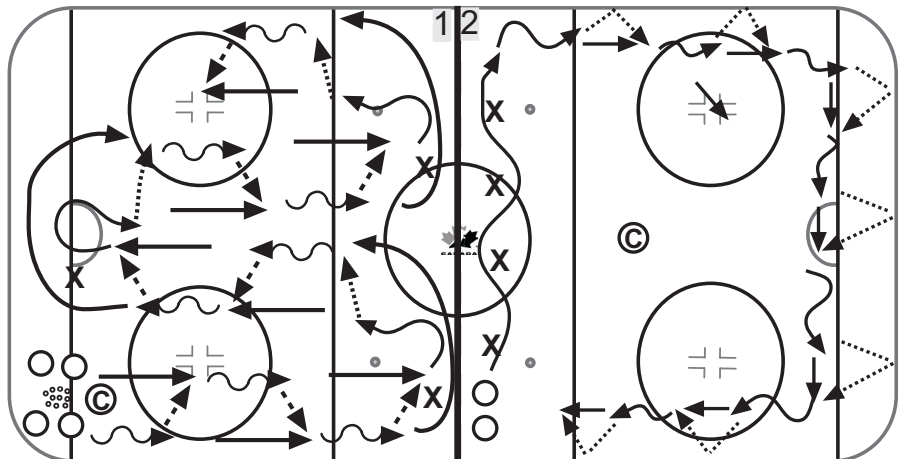

SKILL STATIONS #3 - 6 STATION SETUP

1. PAIRS PASSING (2.4.01/2.4.02)
2. TAG
3. V-START/TIGHT TURNS (1.3.02/1.6.02)
4. BANK PASS (2.3.07)
5. CIRCLE KEEP AWAY
6. PIGGY BANK RACE

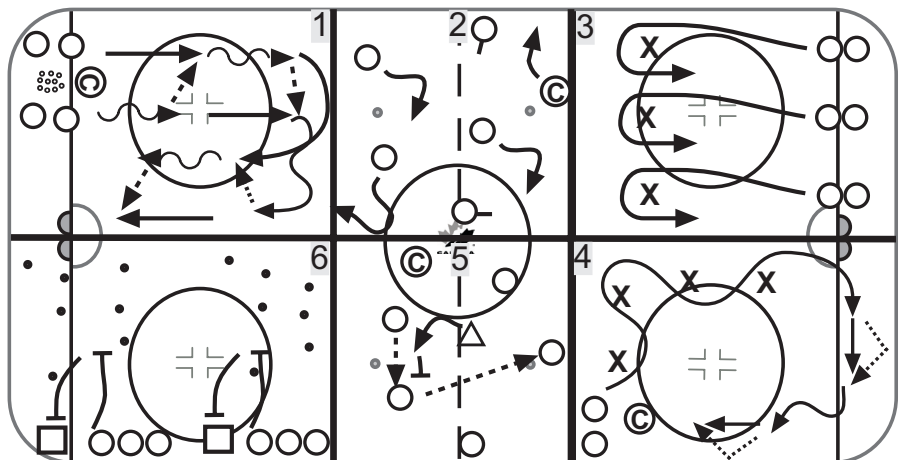

Session Objectives: 1. Introduce: Backhand Shot, Starting with the Puck
2. Review: Forehand Shot, Skating with the Puck, Stationary Stickhandling

10 MIN

WARM-UP

WARM UP 1.1.03/1.6.04/1.6.12/1.3.03/1.3.07

Players skate anywhere on ice. Coaches are "it" and try to tag players. If tagged, players must go to the "Skill Doctor" at the referee's circle who assigns a skill task which player performs before returning to the game. Suggested skill tasks: jumping on one foot, 360's, crossovers – three quick, lateral crossovers, crossover start, 1 foot stop.

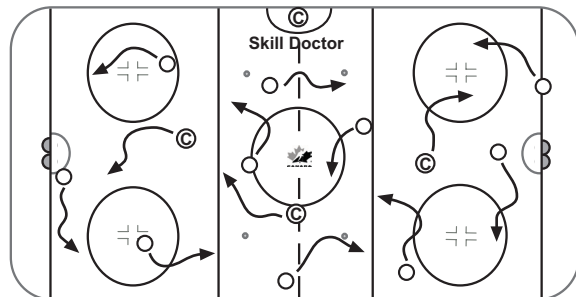

20 MIN

SKILL STATIONS #1

1. HORSE AND BUGGY (1.1.07/1.1.08/1.3.07/1.4.13)

Players partner up on goal line. One player pulls other across ice using two hockey sticks, blades down. Alternate players on return trip. Player being pulled glides on 1 foot. Repeat gliding on one foot backwards. Go slow and safe! Repeat again with glider providing resistance by executing one foot stop (spray snow on pylon) and immediately uses T-push to start and return to group. Partner goes. Puller must create power with long, low strides. Focus on puller's posture, body angle, stride length and recovery.

2. ONE FOOT STOP AND T-PUSH (1.3.07/1.3.01)

Review and demonstrate key points. Divide group into groups of 2-3 players. Place pylons 2/3 across ice for each group. On signal 1st player executes front start and skates to pylon, executes one-foot stop (spray snow on pylon) and immediately uses T-push to start and return to group. Partner goes. Coaches supervise for proper technique.

3. PAIR PASSING (2.4.01/2.4.02)

Players skate in pairs the length of the ice and pass the puck to each other. Make sure passes are taken on forehand and backhand as appropriate.

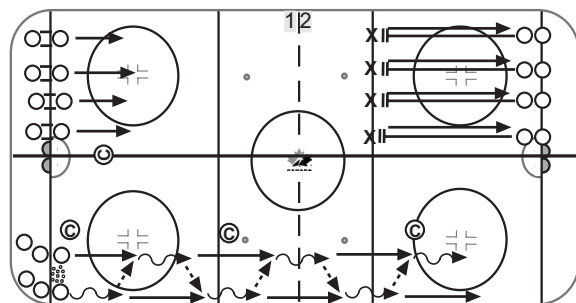

20 MIN

SKILL STATIONS #2

1. CROSSOVERS (1.6.10)

Review and demonstrate. Players skate around the face-off circles performing forward crossovers. Stay on or outside the line. To pass player in front must go on outside. Send 4-5 players at once.

2. STATIONARY STICKHANDLING (2.1.18)

Players partner up with one partner on their knees with their stick in front of them. The second player is standing stationary and stickhandles the puck around and through their partner's stick using toe drags.

3. BANK PASS (2.3.07)

Players partner up and pass the puck back and forth using the boards. Place a pylon between the two players to provide an obstacle. Repeat using backhand.

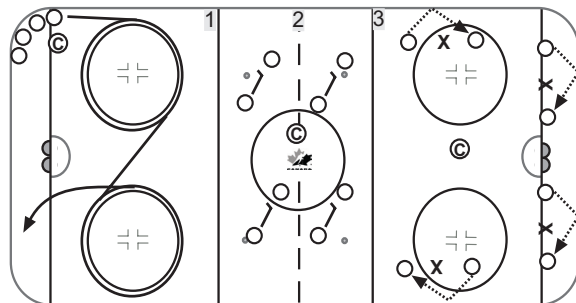

10 MIN

FUN GAME

IMPACT PYLONS

Players start at one end of the ice. Coaches on boards in centre ice zone (both sides). On signal players skate from one end to the other, coaches shoot small pylons at players. Any player hit is eliminated and helps the coaches. Continue until winner declared.

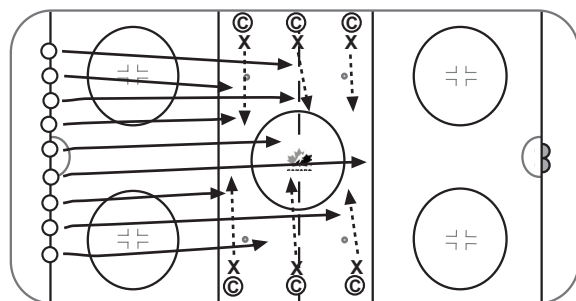

Do not forget to incorporate the Warm-up session prior to introducing your skill stations and the fun game at the end of your practice from the previous page.

Additional ice stations: You may choose either Option 1: Skill Stations #1 plus Skill Skations #2, Option 2: Skills Stations #2 repeated 3 times or Option 3: Skill Stations #3 only

SKILL STATIONS #1 - 4 STATION SETUP

- 1. HORSE AND BUGGY (1.1.07/1.1.08/1.3.07/1.4.13)
- 2. BANK PASS (2.3.07)
- 3. STATIONARY STICKHANDLING (2.1.18)
- 4. ONE FOOT STOP AND T-PUSH (1.3.07/1.3.01)

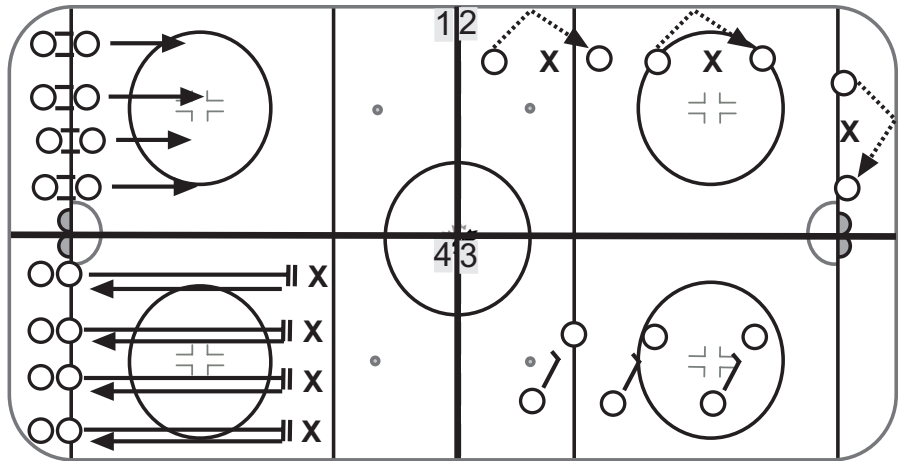

SKILL STATIONS #2 - 2 STATION SETUP

- 1. CROSSOVERS (1.6.10)
- 2. PAIR PASSING (2.4.01/2.4.02)

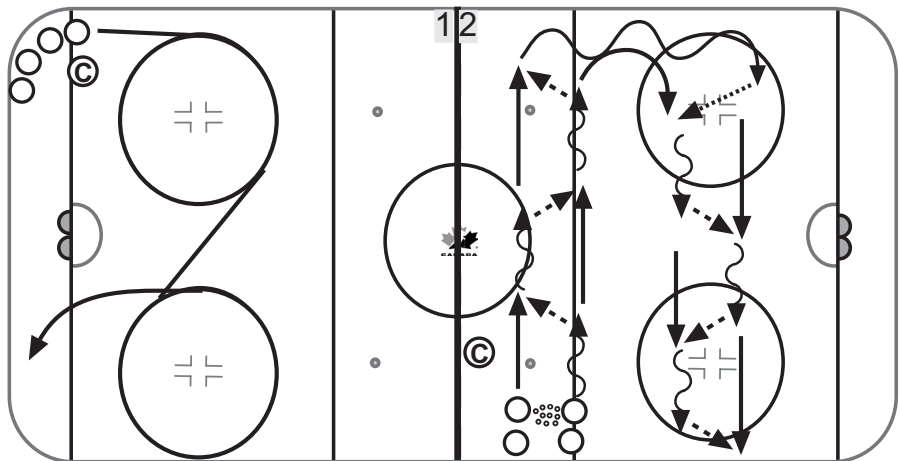

SKILL STATIONS #3 - 6 STATION SETUP

- 1. CROSSOVERS (1.6.10)
- 2. STATIONARY STICKHANDLING (2.1.18)
- 3. ONE FOOT STOP AND T-PUSH (1.3.07/1.3.01)
- 4. BANK PASS (2.3.07)
- 5. HORSE AND BUGGY (1.1.07/1.1.08/1.3.07/1.4.13)
- 6. PAIR PASSING (2.4.01/2.4.02)

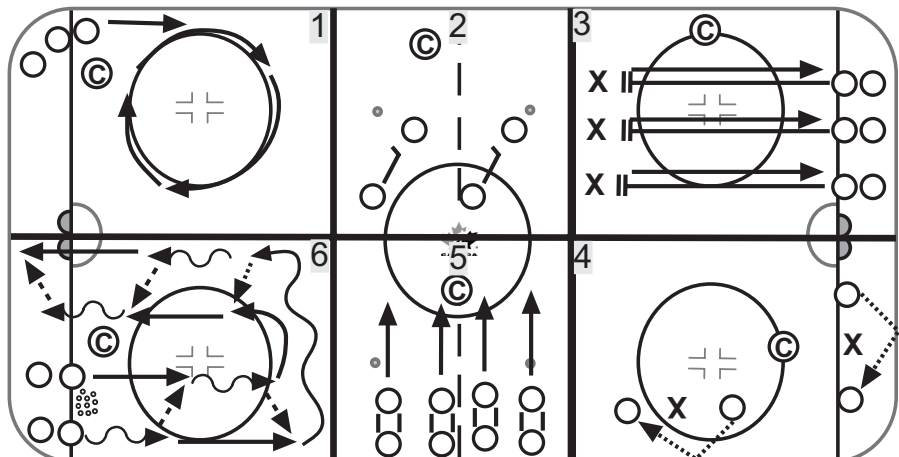

Session Objectives: 1. Introduce: 1 Foot Backward Glide, V Stop & Front Start
2. Review: 2 Foot Stop & T-Push, Crossovers, Puckhandling

10 MIN

WARM-UP

WARM UP (2.2.01/2.2.02/2.2.03/2.2.04/2.2.08/2.2.23)

Players skate around ice any direction handling puck. Put out nets for shooting. Have players stickhandle narrow, wide, narrow and wide combination, side-front-side, weave, and toe drag. Encourage players to bounce it off the boards, vary speed, and change direction. Scatter pylons to be avoided by players. Each time the player crosses a line they must drop puck into skates and kick back up to stick.

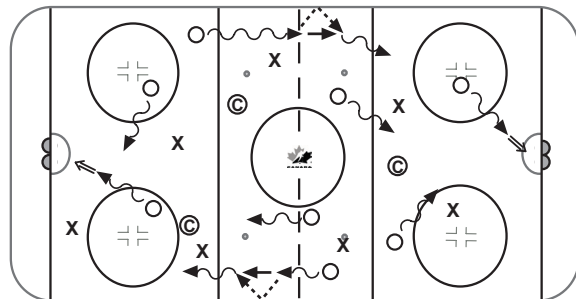

20 MIN

SKILL STATIONS #1

1. HORSE AND BUGGY (1.5.07/1.5.03/1.5.04)

Review and demonstrate key points. Partners face each other holding sticks blades down. Player on boards pushes partner backward. Player being pushed starts gliding on two skates then switches to one skate. Even short distances are good. Reverse positions on return. Repeat using other foot. Slow and safe!

2. CHANGING DIRECTION (1.3.03/1.3.07/1.3.01)

Review and demonstrate. Divide group into groups of 2-3 players. Place pylons 2/3 across ice for each group. On signal 1st player executes front crossover start and skates to pylon, executes one-foot stop (spray snow on pylon) and immediately uses T-push to start and return to group. Partner goes. Coaches supervise for proper technique - when technique achieved go to next step. Run drill as relay. 1 coach supervises each pylon. Team that has most correct executions in 1 minute wins - speed helps but proper technique is more important.

3. STATIONARY STICKHANDLING (2.1.18/2.1.19)

Players partner up with one partner on their knees with their stick in front of them. The second player is standing stationary and stickhandles the puck around and through their partners stick using toe drags. Repeat with stick moving.

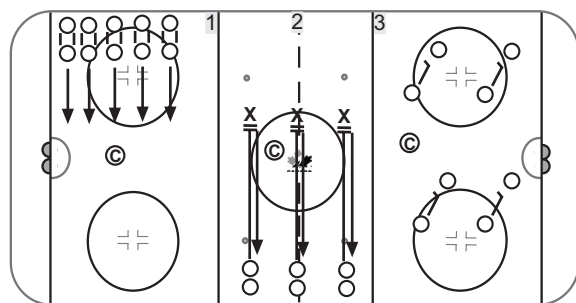

20 MIN

SKILL STATIONS #2

1. CROSSOVERS (1.6.10/1.6.11)

Review and demonstrate. Players skate around the face-off circles performing forward crossovers. Stay on or outside the line. To pass player in front must go on outside. Send 4-5 players at once. Repeat while grabbing stick low.

2. CHANGING DIRECTION (1.3.04/1.5.02/1.3.11/1.3.02)

Review key points of basic stance, C-Cut, striding and backward V stop. Players partner off. Paint a line 1/2 way across ice. On signal 1st player performs C-Cut to start, alternate feet, then push and glide across ice, perform backward V-stop at line and immediately perform forward (running) start to return to partner who then goes. Coaches supervise for proper technique. Check for good backward stance, stick in one hand, glide foot directly under centre of gravity, push foot extends sideways using front part of blade.

3. BANK PASS (2.3.07)

Players partner up and pass the puck back and forth using the boards. Place a pylon between the two players to provide an obstacle. Repeat using backhand.

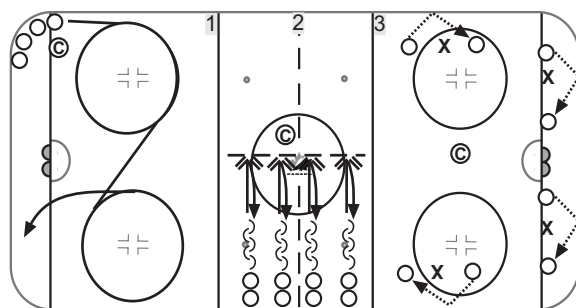

10 MIN

FUN GAME

A BUGS LIFE

Place pucks (food) at centre ice and nets at each end. Players (ants) control puck and try to put in nets (ant hills) while coaches (grasshoppers) try to take pucks away. Player can try to take puck back from coach or go and get another puck. Ants try to get all the food into the ant hill before winter (the whistle).

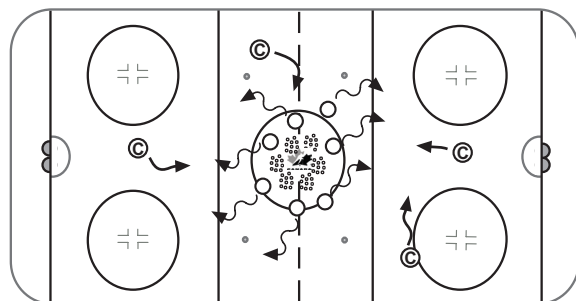

Do not forget to incorporate the Warm-up session prior to introducing your skill stations and the fun game at the end of your practice from the previous page.

Additional ice stations: You may choose either Option 1: Skill Stations #1 plus Skill Skations #2, Option 2: Skills Stations #2 repeated 3 times or Option 3: Skill Stations #3 only

SKILL STATIONS #1 - 4 STATION SETUP

1. HORSE AND BUGGY (1.5.07/1.5.03/1.5.04)
2. CHANGING DIRECTION (1.3.03/1.3.07/1.3.01)
3. CHANGING DIRECTION (1.3.04/1.5.02/1.3.11/1.3.02)
4. STATIONARY STICKHANDLING (2.1.18/2.1.19)

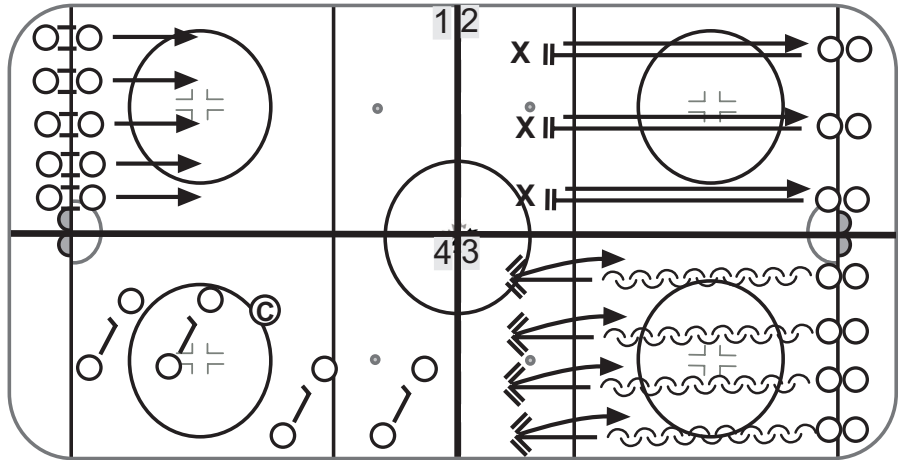

SKILL STATIONS #2 - 2 STATION SETUP

1. CROSSOVERS (1.6.10/1.6.11)
2. BANK PASS (2.3.07)

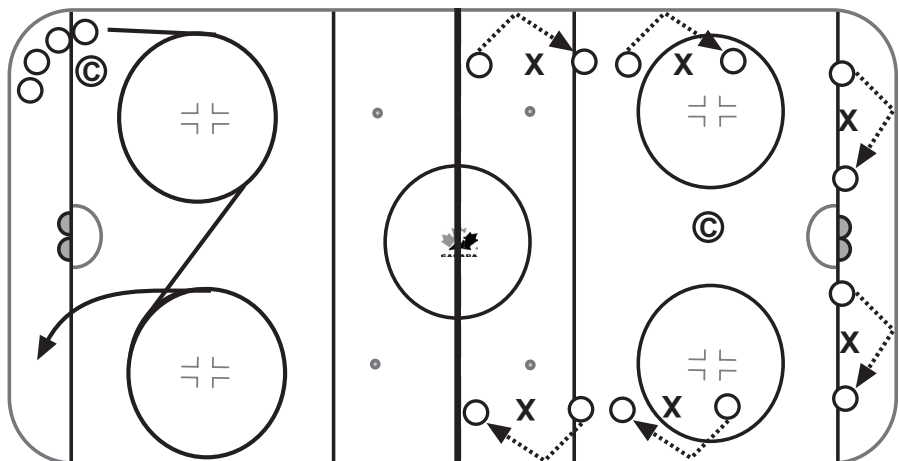

SKILL STATIONS #3 - 6 STATION SETUP

1. CROSSOVERS (1.6.10/1.6.11)
2. STATIONARY STICKHANDLING (2.1.18/2.1.19)
3. CHANGING DIRECTION (1.3.04/1.5.02/1.3.11/1.3.02)
4. CROSSOVERS (1.6.10/1.6.11)
5. HORSE AND BUGGY (1.5.07/1.5.03/1.5.04)
6. CHANGING DIRECTION (1.3.03/1.3.07/1.3.01)

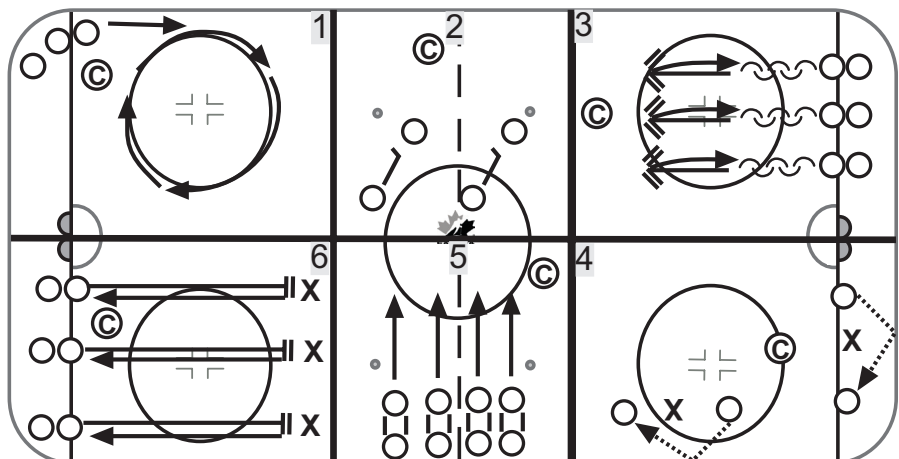

Session Objectives: 1. Introduce: Open Ice, 1 Foot Backward Stop & T-Push
2. Review: ABC's, V Stop & Front Start

10 MIN

WARM-UP

WARM UP (2.2.01/2.2.02/2.2.03/2.2.04/2.2.08/2.2.23)

Players skate around ice any direction handling puck. Put out nets for shooting. Have players stickhandle narrow, wide, narrow and wide combination, side-front-side, weave, and toe drag. Encourage players to bounce it off the boards, vary speed, and change direction. Scatter pylons to be avoided by players. Each time the player crosses a line they must drop puck into skates and kick back up to stick.

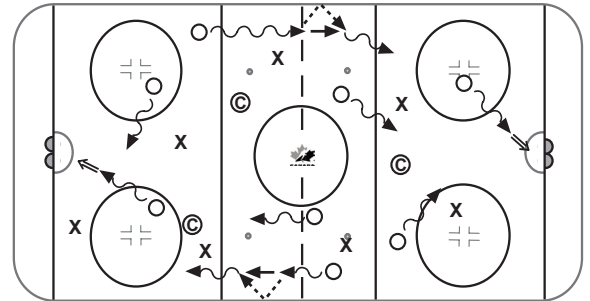

20 MIN

SKILL STATIONS #1

1. OPEN ICE CARRY (2.2.05/2.2.06/2.2.07)

Players cross ice maintaining contact with the stick. Repeat 3-4 times. Review and demonstrate key points. Players cross ice pushing the puck ahead with the bottom edge of the stick. Flip stick over to control direction of the puck. Repeat 3-4 times.

2. 1 FOOT BACKWARD STOP & T-PUSH (1.6.20)

Review key points of basic stance, C-Cut, striding and 1 foot backward stop.

Players partner off. Paint a line ½ way across ice. On signal 1st player performs C-Cut to start, alternate feet, then push and glide across ice, perform backward 1 foot stop at line. When player stops they should be in T-push position. Immediately push down and out (T-push) to start forward and return to partner. Coaches supervise for proper technique.

3. PAIRS PASSING (2.4.01/2.4.02)

Players skate in pairs around the zone and pass the puck to each other. Make sure passes are taken on forehand and backhand as appropriate.

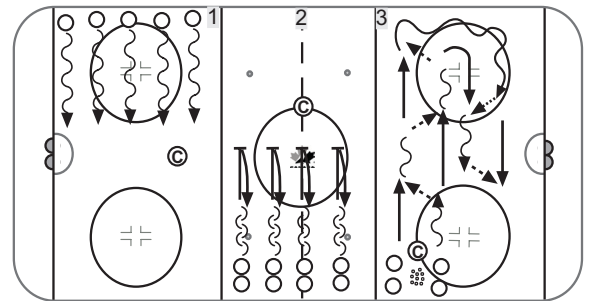

20 MIN

SKILL STATIONS #2

1. V-STOP AND FRONT START (1.3.04/1.3.11/1.3.02)

Review key points of basic stance, C-Cut, striding and backward V stop. Players partner off. Paint a line ½ way across ice. On signal 1st player performs C-Cut to start, alternate feet, then push and glide across ice, perform backward V-stop at line and immediately perform forward (running) start to return to partner who then goes. Coaches supervise for proper technique. Run drill as relay. Coach supervises each pair. Team that has most correct executions in 1 minute wins - speed helps but proper technique is more important.

2. FOLLOW THE LEADER

Challenge the players to do the following things (requires enthusiasm - act surprised when kids accomplish tasks, tell them they can't do the next one): Penguin walk; Stand facing boards - Turn and face opposite boards in one step. Turn again to face original boards in one step. Repeat, turning other direction. (These are pivots, but standing still); Cross ice gliding on two skates; Cross ice gliding on one skate. Repeat, gliding on other skate; Cross ice and glide with knee bend; Cross ice and glide on one skate, extend other leg out behind at hip height and arms out (the "Airplane"); Cross ice and glide on one skate, extend other leg out in front; Players take enough strides backwards to gain momentum then glide on one skate. Lift other skate out in front and glide in a straight line backward. Return, gliding on other skate; Repeat except lift leg back and lean forward (the "Airplane"). Return on other foot.

3. STATIONARY STICKHANDLING (2.1.20)

Line players up in stickhandling position with a puck in front of them. Have players stickhandle the puck through their legs.

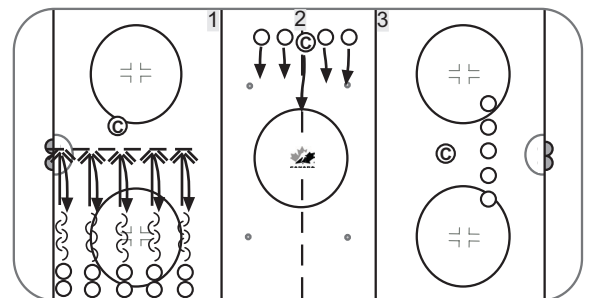

10 MIN

FUN GAME

CROSS ICE SCRIMMAGE

No nets - use 1 pylon - must hit pylon to score - no goalies. Continuous play - if a goal is scored players give puck to coach who shoots it in to area and play continues. If stronger players monopolize the puck, add another puck (or two).

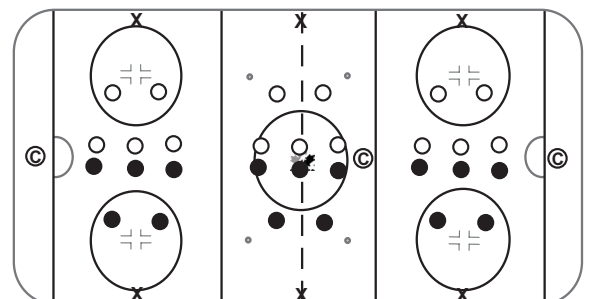

Do not forget to incorporate the Warm-up session prior to introducing your skill stations and the fun game at the end of your practice from the previous page.
 Additional ice stations: You may choose either Option 1: Skill Stations #1 plus Skill Skations #2, Option 2: Skills Stations #2 repeated 3 times or Option 3: Skill Stations #3 only

SKILL STATIONS #1 - 4 STATION SETUP

1. FOLLOW THE LEADER
2. V-STOP AND FRONT START (1.3.04/1.3.11/1.3.02)
3. STATIONARY STICKHANDLING (2.1.20)
4. 1 FOOT BACKWARD STOP & T-PUSH (1.6.20)

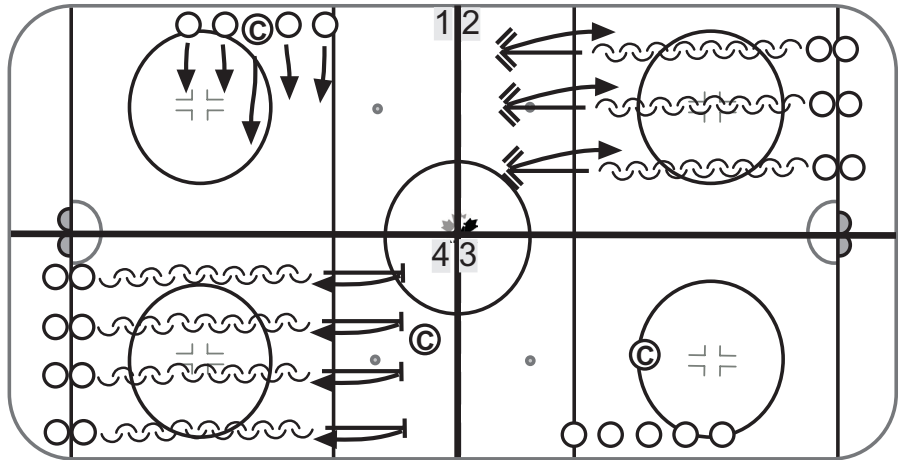

SKILL STATIONS #2 - 2 STATION SETUP

1. PAIRS PASSING (2.4.01/2.4.02)
2. OPEN ICE CARRY (2.2.05/2.2.06/2.2.07)

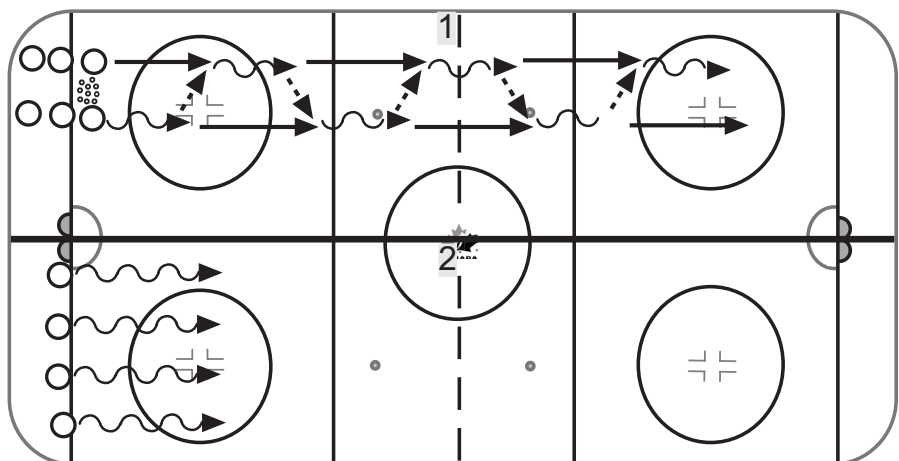

SKILL STATIONS #3 - 6 STATION SETUP

1. V-STOP AND FRONT START (1.3.04/1.3.11/1.3.02)
2. FOLLOW THE LEADER
3. OPEN ICE CARRY (2.2.05/2.2.06/2.2.07)
4. 1 FOOT BACKWARD STOP & T-PUSH (1.6.20)
5. STATIONARY STICKHANDLING (2.1.20)
6. PAIRS PASSING (2.4.01/2.4.02)

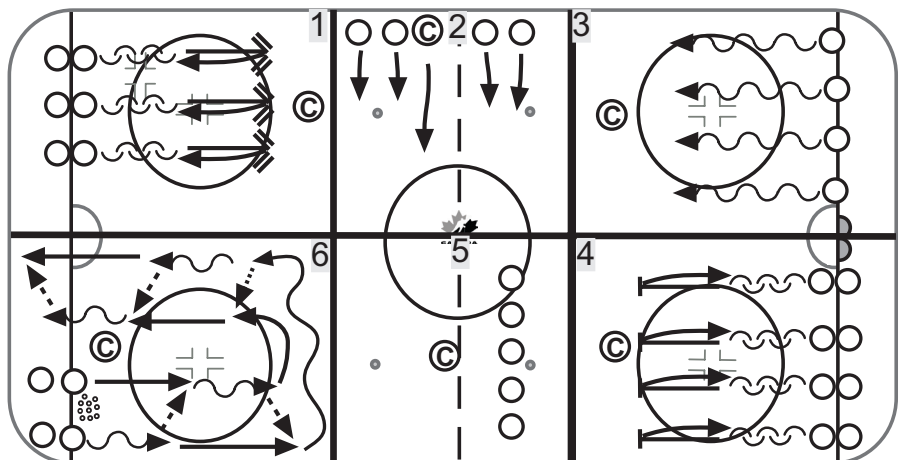

Session Objectives: 1. Introduce: : Pivots - Forward to Backward & Backward to Forward
2. Review: Open Ice Carry, 1 Foot Backward Stop & T-Push, ABC

10 MIN

WARM-UP

WARM UP (2.2.01/2.2.02/2.2.03/2.2.04/2.2.08/2.2.23/2.2.20)

Players skate around ice any direction handling puck. Put out nets for shooting. Have players stickhandle narrow, wide, narrow and wide combination, side-front-side, weave, stick through legs, and toe drag. Encourage players to bounce it off the boards, vary speed, change direction. Scatter pylons to be avoided by players. Each time the player crosses a line they must drop puck into skates and kick back up to stick.

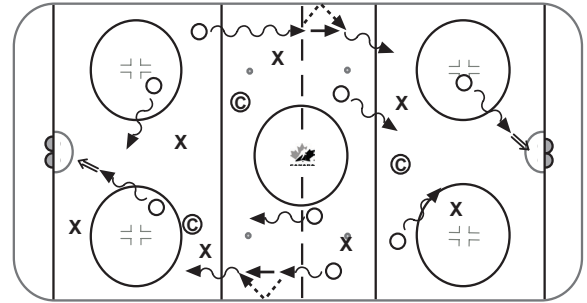

20 MIN

SKILL STATIONS #1

1. PIVOTS - FORWARD TO BACKWARD & BACKWARD TO FORWARD (1.6.21)

Players perform penguin walk. Stand facing boards. Turn and face opposite boards in one step. Turn again to face original boards in one step. Repeat, turning other direction. (These are pivots, but standing still). Review key points of pivots and demonstrate. Divide into two groups. Groups start as indicated in diagram. Group 1 skates backward to pylon (or paint line) and performs pivot - backward to forward. Accelerate out of turn and perform two-foot stop at boards and joins group 2 line. 2nd player can go when 1st is 1/2 way to pylon. Group 2 skates forward to pylon (or paint line) and performs pivot - forward to backward. Skates backwards to boards perform V-stop at boards and joins group 1 line. 2nd player can go when 1st reaches pylon.

2. FOLLOW THE LEADER

Challenge the players to do the following things (requires enthusiasm - act surprised when kids accomplish tasks, tell them they can't do the next one): Cross ice gliding on two skates; Cross ice gliding on one skate; Cross ice glide with knee bend; Cross ice and glide on one skate, extend other leg out behind at hip height (the "Airplane"); Cross ice and glide on one skate, extend other leg out in front; Cross ice, glide and touch heels with hands; Cross ice gliding on two skates; Go halfway with skates far apart, other half skates close together; Ride the Broom.

3. STATIONARY STICKHANDLING (2.1.20)

Line players up in stickhandling position with a puck in front of them. Have players stickhandle the puck through their legs.

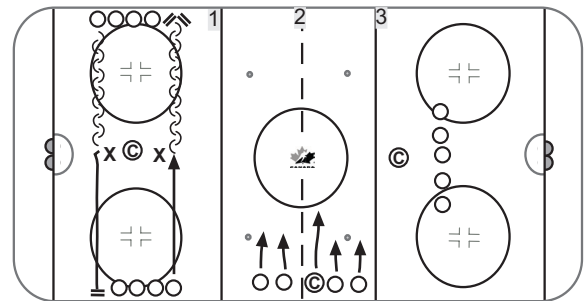

20 MIN

SKILL STATIONS #2

1. OPEN ICE CARRY (2.2.05/2.2.06/2.2.07)

Review and demonstrate key points. Players partner off. Place pylons 20 metres out from boards - one for every two players. Player pushes puck slightly ahead of them. Skate out to it and perform open ice carry, pushing puck with bottom edge of stick blade. Players perform tight turn around pylon controlling puck and return using open ice carries. Teams can compete - e.g. how many times team can complete in 2 minutes.

2. CROSSOVERS - FOUR PYLON RACE (1.6.19)

Review key points. Arrange pylons in a square. 4 Players begin at 4 corners of the square. On coaches signal, players race twice around square trying to catch player in front of them.

3. 1 FOOT BACKWARD STOP AND T-PUSH (1.6.20)

Review key points of basic stance, C-Cut, striding and 1 foot backward stop. Players partner off. Paint a line 1/2 way across ice. On signal 1st player performs C-Cut to start, alternate feet, then push and glide across ice, perform backward 1 foot stop at line. When player stops they should be in T-push position. Immediately push down and out (T-push) to start forward and return to partner. Coaches supervise for proper technique. Run drill as relay. Coach supervises each pair. Team that has most correct executions in 1 minute wins - speed helps but proper technique is more important.

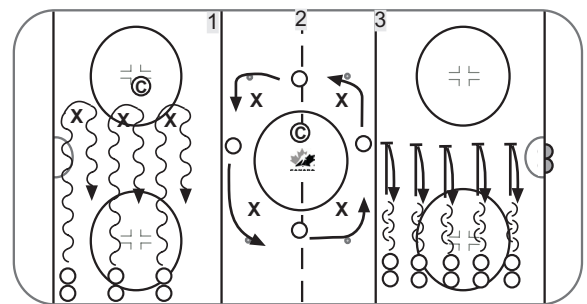

10 MIN

FUN GAME

IMPACT PYLONS

Players start at one end of the ice. Coaches on boards in centre ice zone (both sides). On signal players skate from one end to the other, coaches shoot small pylons at players. Any player hit is eliminated and helps the coaches. Continue until winner declared.

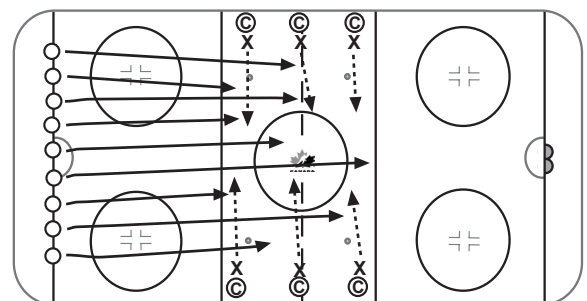

Do not forget to incorporate the Warm-up session prior to introducing your skill stations and the fun game at the end of your practice from the previous page.
 Additional ice stations: You may choose either Option 1: Skill Stations #1 plus Skill Skations #2, Option 2: Skills Stations #2 repeated 3 times or Option 3: Skill Stations #3 only

SKILL STATIONS #1 - 4 STATION SETUP

1. STATIONARY STICKHANDLING (2.1.20)
2. FOLLOW THE LEADER
3. 1 FOOT BACKWARD STOP AND T-PUSH (1.6.20)
4. OPEN ICE CARRY (2.2.05/2.2.06/2.2.07)

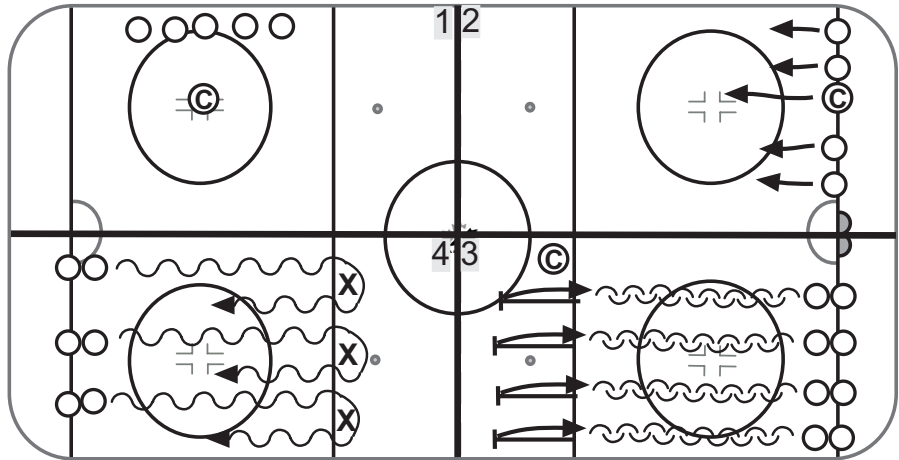

SKILL STATIONS #2 - 2 STATION SETUP

1. PIVOTS - FORWARD TO BACKWARD & BACKWARD TO FORWARD (1.6.21)
2. CROSSOVERS - FOUR PYLON RACE (1.6.19)

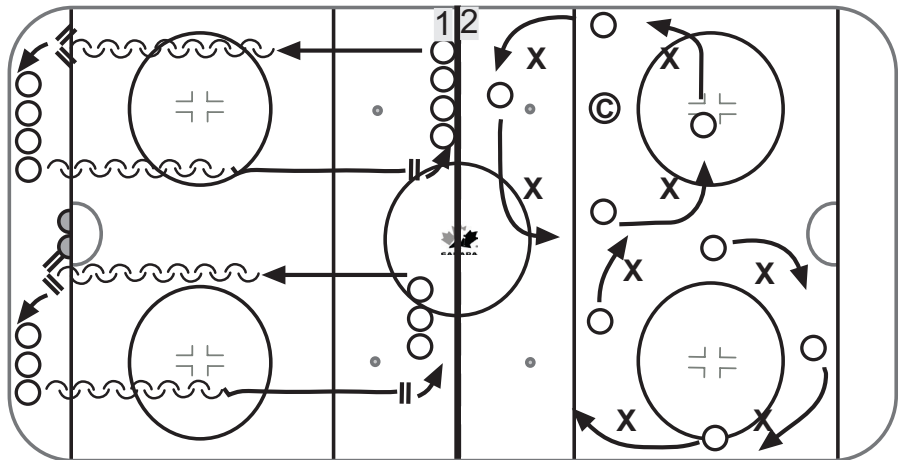

SKILL STATIONS #3 - 6 STATION SETUP

1. PIVOTS - FORWARD TO BACKWARD & BACKWARD TO FORWARD (1.6.21)
2. FOLLOW THE LEADER
3. OPEN ICE CARRY (2.2.05/2.2.06/2.2.07)
4. 1 FOOT BACKWARD STOP AND T-PUSH (1.6.20)
5. STATIONARY STICKHANDLING (2.1.20)
6. CROSSOVERS - FOUR PYLON RACE (1.6.19)

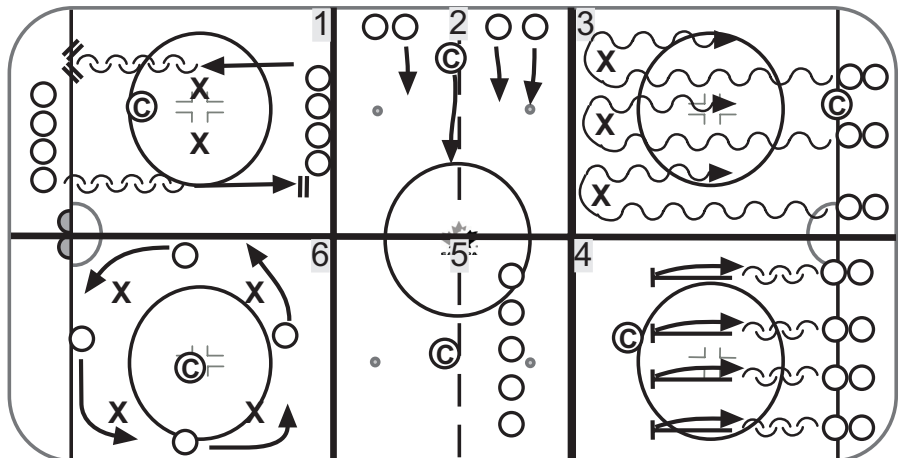



U7 EVALUATION ITEM 1=weak, 10=strong	Player																													
	Name 1	Name 2	Name 3	Name 4	Name 5	Name 6	Name 7	Name 8	Name 9	Name 10	Name 11	Name 12	Name 13	Name 14	Name 15															
	1	R	2	R	3	R	4	R	5	R	6	R	7	R	8	R	9	R	10	R	11	R	12	R	13	R	14	R	15	R
Turning and Crossovers																														
1. C-cuts - around circle - outside foot																														
2. Crossovers - forward																														
3. Crossovers - three quick - left and right																														
4. Backward one-foot stop and t-start																														
Starting and Stopping																														
5. Crossover start																														
6. One-leg backward stop																														
7. Toe drag - side and front																														
8. Partner on knees - moving stick																														
9. Stick through legs																														
10. Rotation																														
11. Puck through legs from back																														
Moving Puck Control																														
12. Open ice carry - forehand																														
13. Open ice carry - backhand																														
14. Stick through legs																														
Stationary Passing and Receiving																														
15. Stationary forhand pass																														
16. Stationary backhand pass																														
17. Stationary bank pass																														
Moving Passing and Receiving																														
18. Moving forehand pass																														
19. Moving backhand pass																														
AVERAGE SCORE																														
OVERALL RANK																														



Team name: _____

Date of Evaluation: _____

Age division: _____

Coach: _____

Note: Evaluate players against players on own team

For an electronic version of this checklist, please visit www.hockeycanada.ca

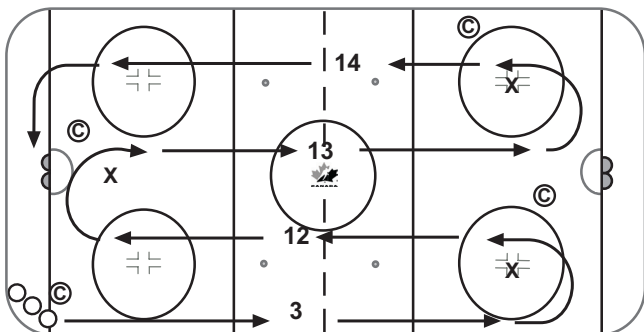

- 3. Crossovers - three quick - left and right
- 12. Open ice carry - forehand
- 13. Open ice carry - backhand
- 14. Stick through legs

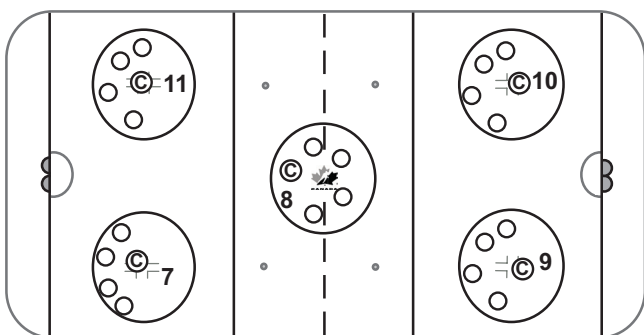

- 7. Toe drag - side and front
- 8. Partner on knees - moving stick
- 9. Stick through legs
- 10. Rotation
- 11. Puck through legs from back

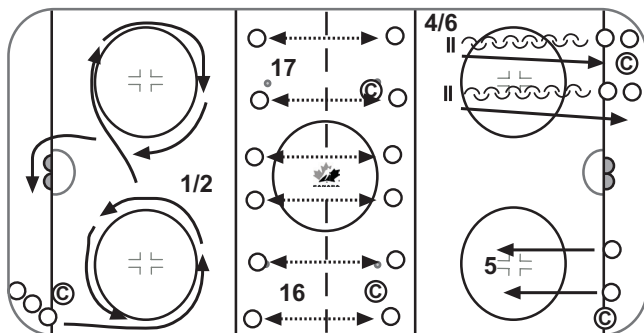

- 1. C-cuts - around circle - outside foot
- 2. Crossovers - forward
- 15. Stationary forehand pass
- 16. Stationary backhand pass
- 5. Crossover start
- 4. Backward one-foot stop and t-start
- 6. One-leg backward stop

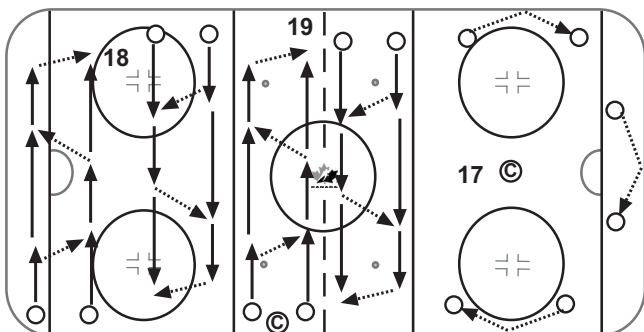

- 18. Moving forehand pass
- 19. Moving backhand pass
- 17. Stationary bank pass